

ERSTELLUNG EINER KORREKTEN DRUCKDATEI - BUCHSTABEN AUS PAPPE

Die folgenden Informationen werden Ihnen dabei helfen, eine korrekte Druckdatei zu erstellen. Falls Sie weitere Zweifel haben sollten, können Sie den FAQ-Bereich unserer Webseite konsultieren, die professionelle Dateiüberprüfung aktivieren oder unseren Kundenservice anrufen.

Mit diesem Produkt können Schriften oder Buchstabensequenzen aus havannafarbener (nicht bedruckter) oder (nur vorderseitig) auf havannerfarbigem Untergrund vierfarbig bedruckter Pappe gestaltet werden.

1 AUSRICHTUNG

Die Option "Ausrichtung" bezieht sich auf die Leserichtung der Schriften: Bei waagerechter Ausrichtung ist sie von links nach rechts, bei senkrechter Ausrichtung von oben nach unten. Je nach gewählter Ausrichtung erhalten Sie eine entsprechende Vorrichtung, dank der Sie die Buchstaben mühelos auf einer eventuellen Fläche positionieren können.

2 ZEICHENSATZ

Die Buchstaben werden in der Schriftart **Helvetica Neue LT Std Black** erstellt. Hier nachstehend finden Sie den verfügbaren Zeichensatz.

ABCDEFGHIJKLMNOPQRSTUVWXYZ
abcdefghijklmnopqrstuvwxyz
0123456789 !?%&@€\$£

OPTION "KEIN DRUCK"

Geben Sie unter "Textfeld" den Satz oder die Buchstabensequenz, die Sie bestellen möchten und wählen Sie die Ausrichtung.



OPTION "DRUCK NUR AUF VORDERSEITE"

Geben Sie unter "Textfeld" den Satz oder die Buchstabensequenz, die Sie bestellen möchten und wählen Sie die Ausrichtung. Die Pappbuchstaben sind nur einseitig, mit einem fortlaufenden Muster bedruckbar, das Sie gemäß den nachstehenden Anweisungen erstellen können.



3 DATEIFORMAT

Senden Sie uns Ihre Datei **im PDF-Format im Maßstab 1:1 (ohne Passwortschutz)**.

4 FARBEN

Bitte beachten Sie, dass die Farben auf dem fertigen Druckerzeugnis **dunkler ausfallen werden, weil der Druckträger Havannafarben** und nicht Papierweiß ist. Außerdem werden die Elemente, die Sie in Ihrer Datei in Weiß sehen, auf dem Druckerzeugnis transparent ausfallen.

Alle zugesandten Dateien **müssen im CMYK-Farbmodus** (Cyan, Magenta, Gelb, Schwarz) mit **Farbprofil Fogra 39 angelegt sein**. In RGB- oder mit PANTONE-Farben zugeschickte Bilder werden automatisch einer Standard-Farbkonvertierung unterzogen.

5 AUFLÖSUNG

Die optimale Auflösung der Druckdateien liegt **zwischen 100 und 150 dpi**.

6 ZUSATZINFORMATIONEN

Die minimale druckbare Linienstärke beträgt 0,5 pt.

7 INDIVIDUELLES MUSTER

Das individuelle Muster muss die Abmessungen von 35x35 cm im Fall von Buchstaben mit der Durchschnittshöhe von 25 cm und 70x70 cm im Fall von Buchstaben mit der Durchschnittshöhe von 50 cm haben.

Laden Sie sich **die Vorlagedatei** des von Ihnen bestellten Produkts von unserer Webseite herunter und verwenden Sie diese als Vorlage zur Positionierung Ihrer Grafik: Darin sind die Abmessungen des Musters bereits richtig eingestellt. **Es ist von grundlegender Bedeutung, dass die grafischen Elemente, die Ihr Muster bilden so angeordnet sind, dass Sie reihenweise fortlaufend multipliziert werden können.** Anschließend speichern Sie die PDF-Datei ohne Beschnittzugaben, Schnitt- oder Passermarken.

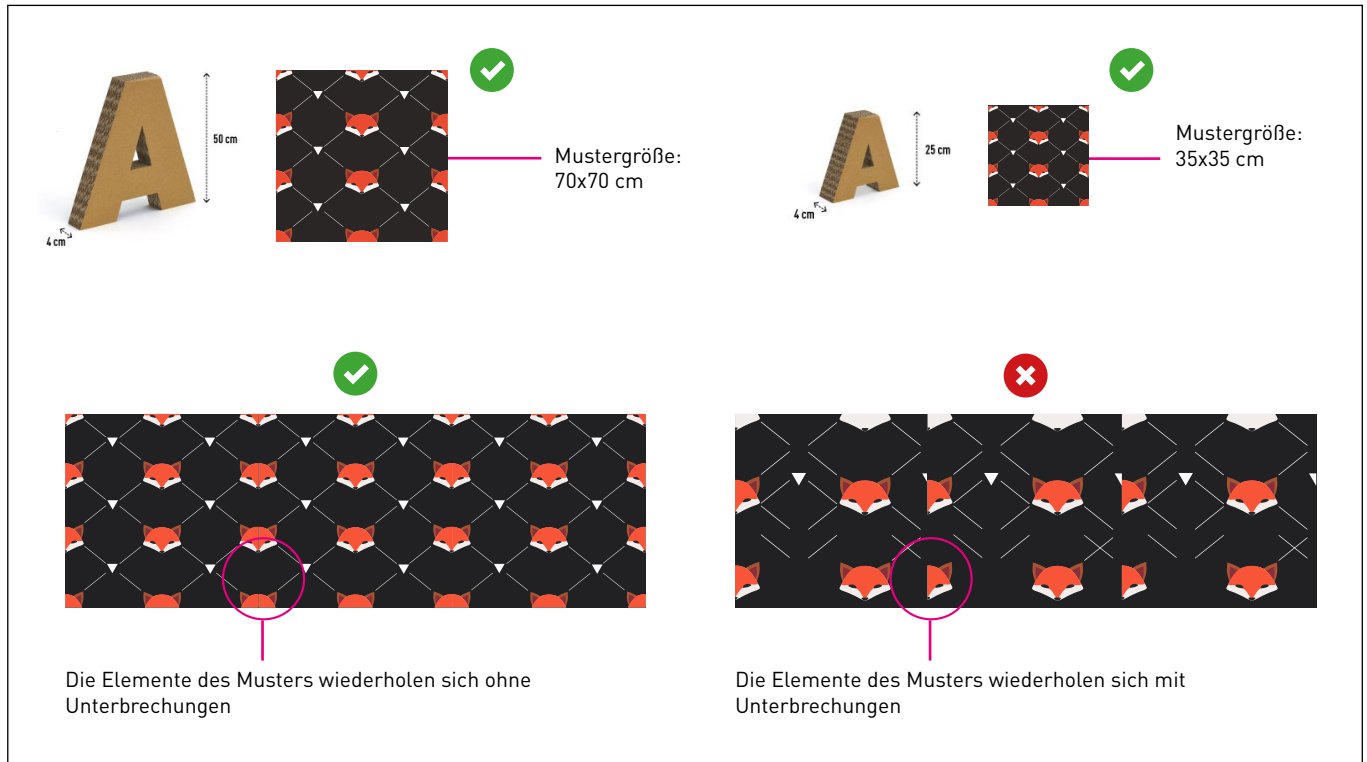

Waagerechte Ausrichtung

WoW

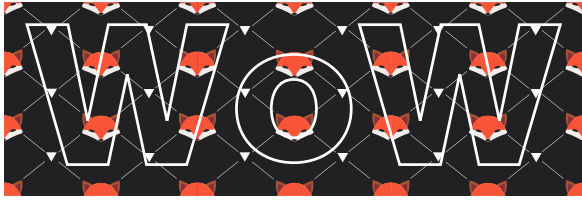

Senkrechte Ausrichtung

**W
o
W**

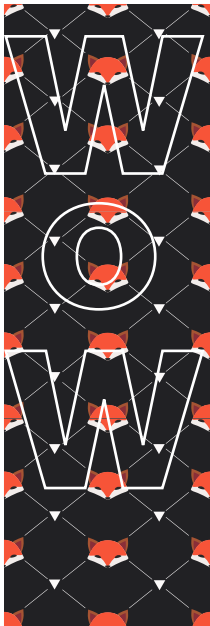

Die Farben werden dunkler ausfallen, als in Ihrer Druckdatei, weil der Druckträger Havannafarben ist. Außerdem werden die Elemente, die Sie in Ihrer Datei in Weiß sehen, auf dem Druckerzeugnis transparent ausfallen.

ANMERKUNG - Bedruckte Buchstaben aus Pappe

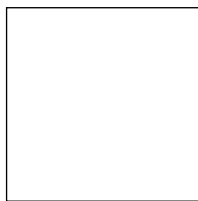

LADEN SIE SICH
DIE VORLAGE HERUNTER

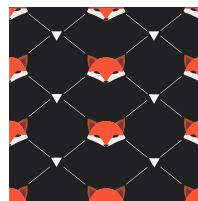

FÜGEN SIE
IHR MUSTER EIN



SPEICHERN SIE
DIE PDF-DATEI



PDF



100-150 dpi



CMYK



FOGRA 39



BESCHNITZUGABE



SCHNITTMARKEN

25 cm hohe BUCHSTABEN

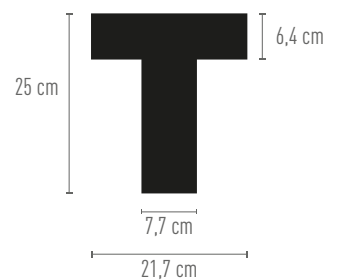
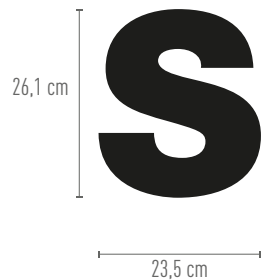
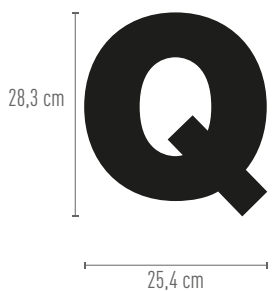
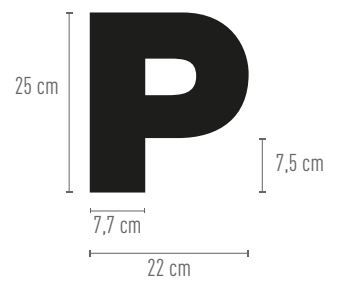
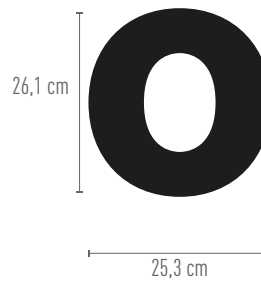
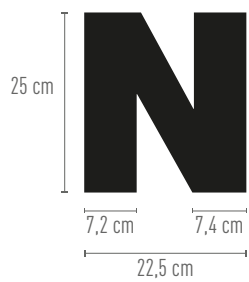
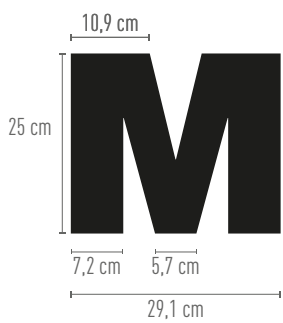
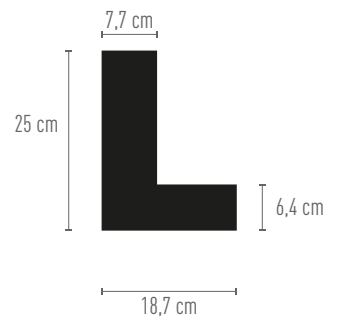
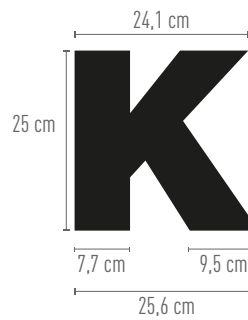
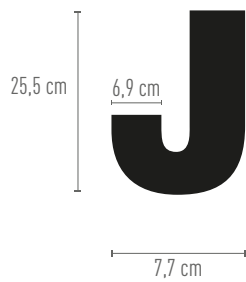
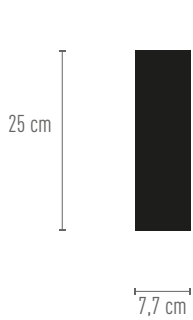
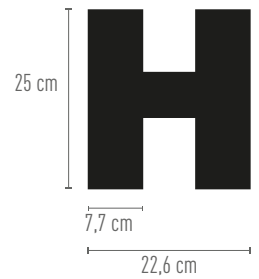
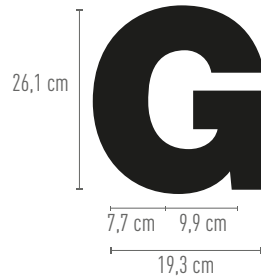
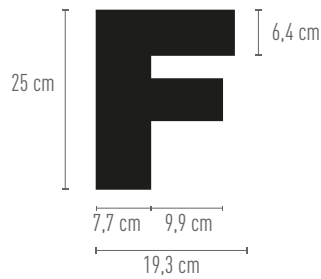
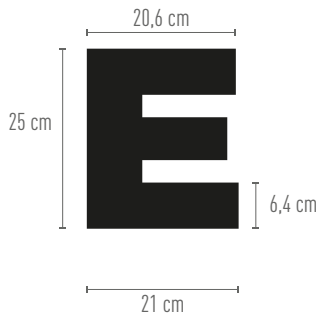
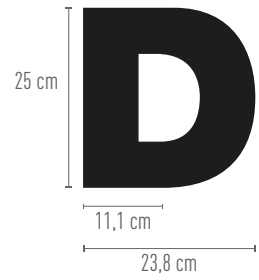
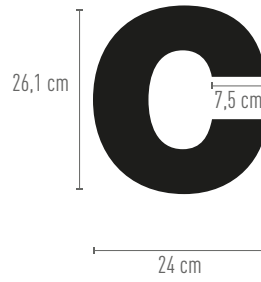
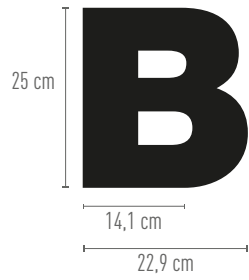
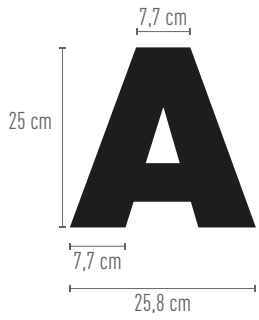

25 cm hohe BUCHSTABEN

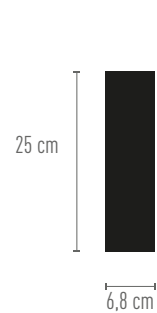
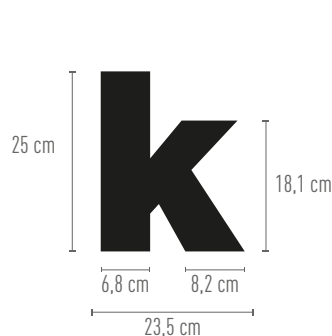
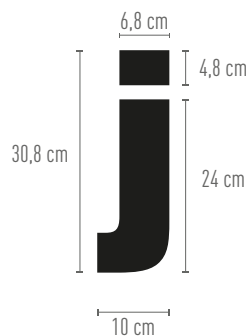
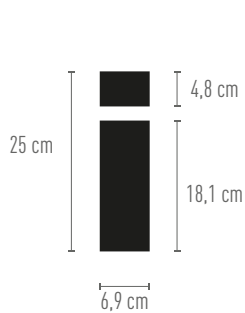
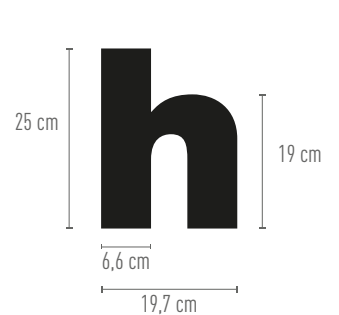
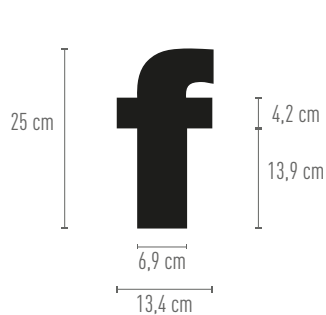
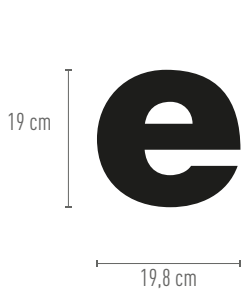
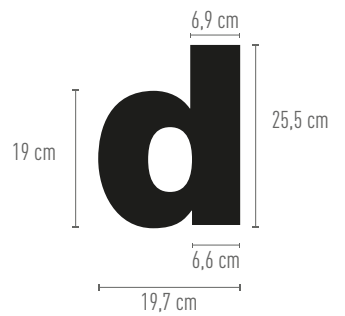
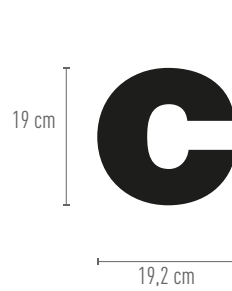
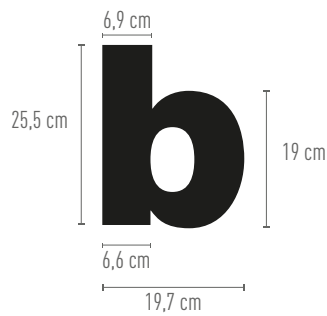
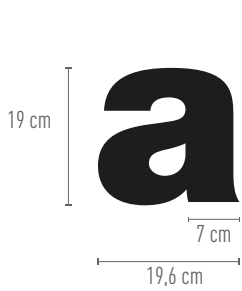
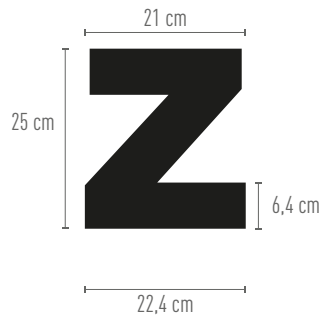
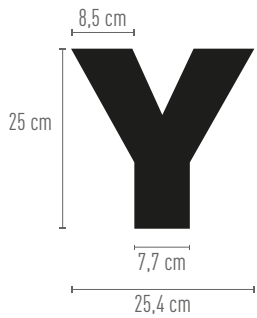
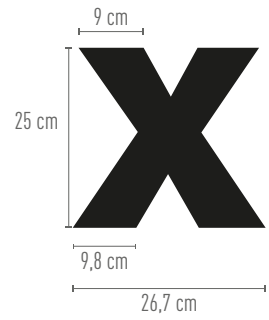
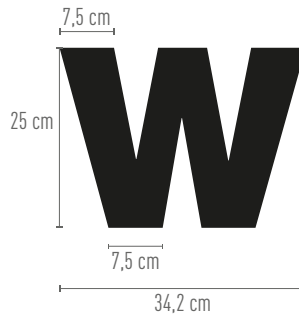
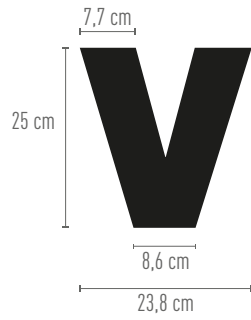

25 cm hohe BUCHSTABEN

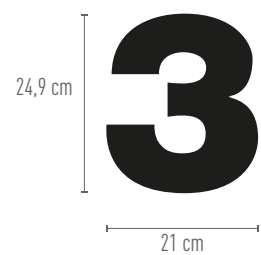
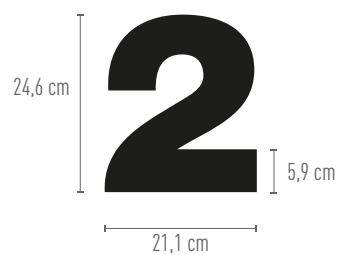
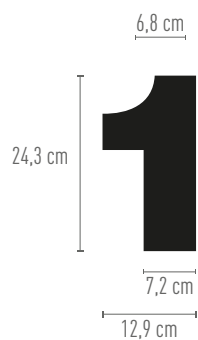
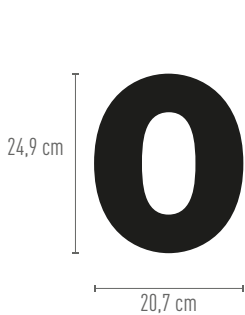
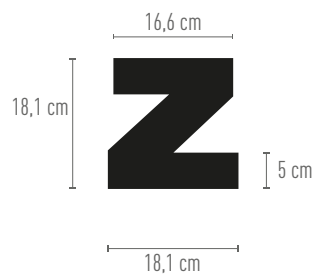
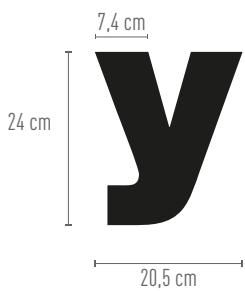
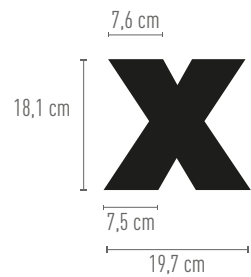
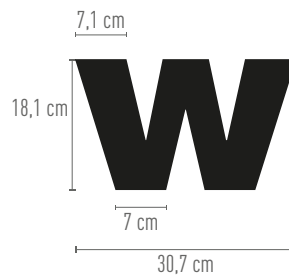
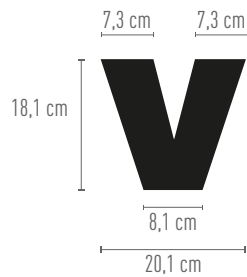
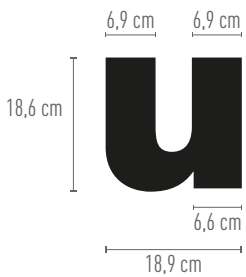
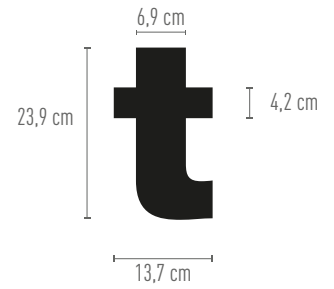
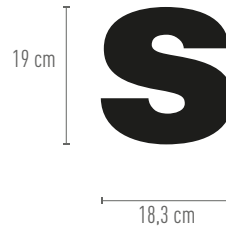
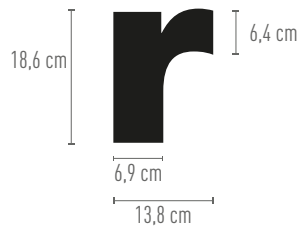
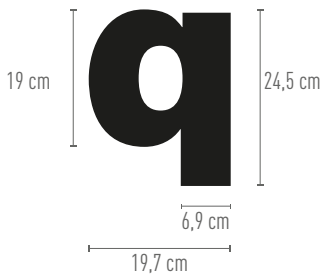
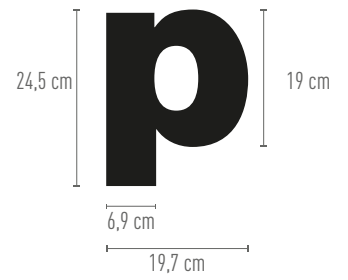
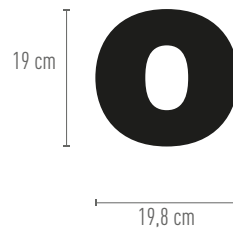
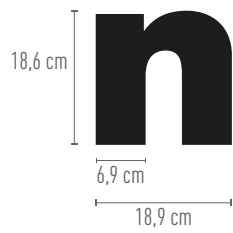
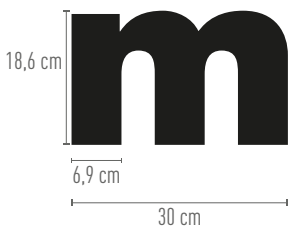

25 cm hohe BUCHSTABEN

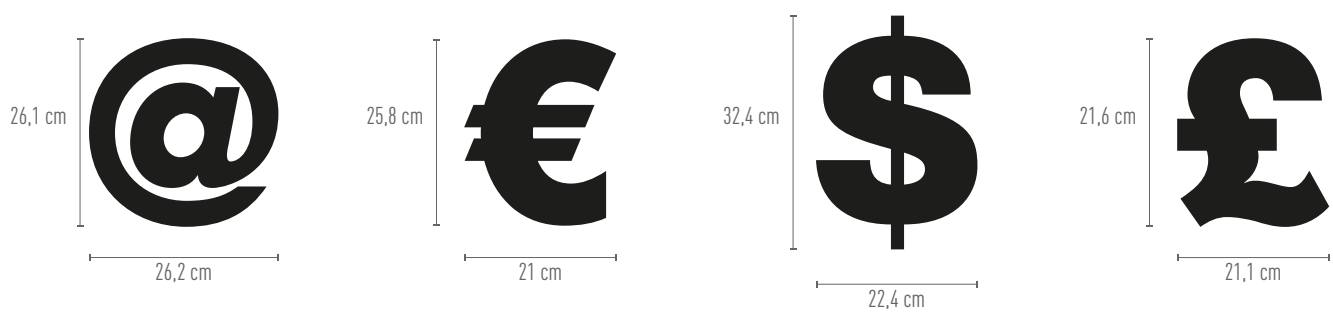
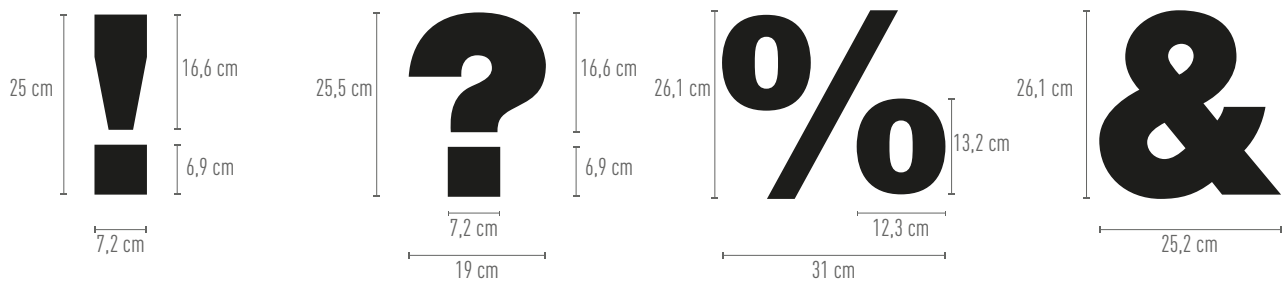
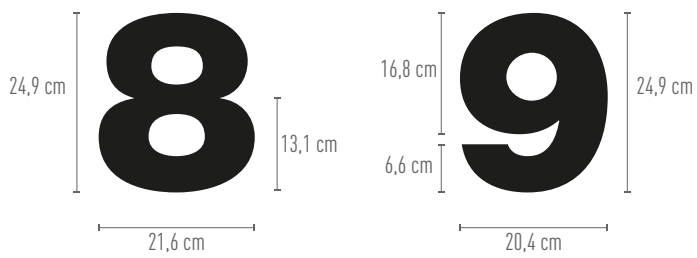
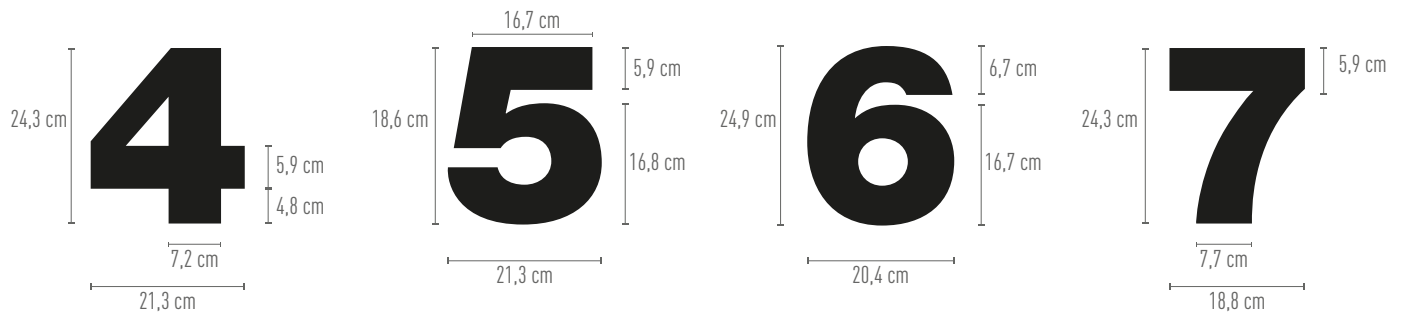

50 cm hohe BUCHSTABEN

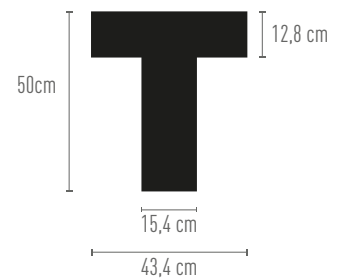
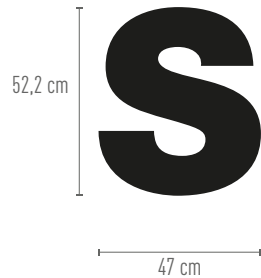
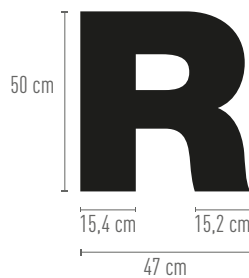
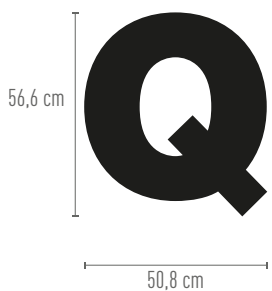
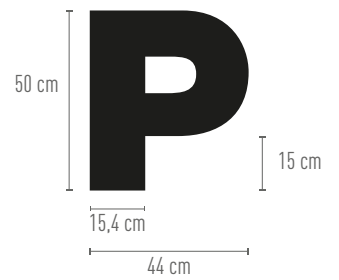
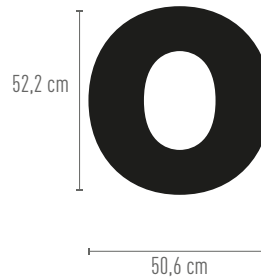
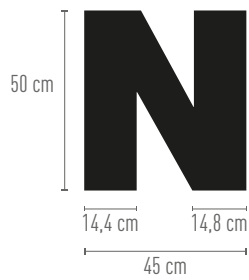
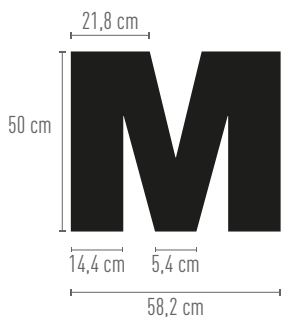
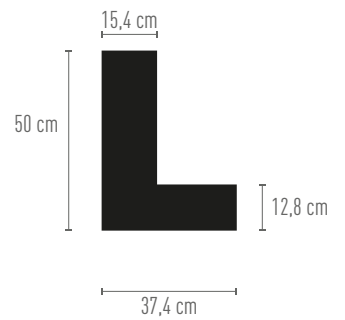
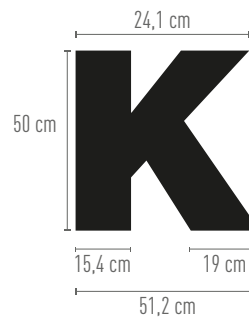
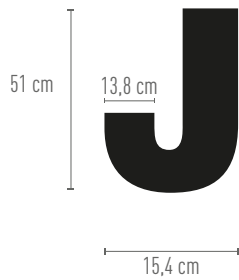
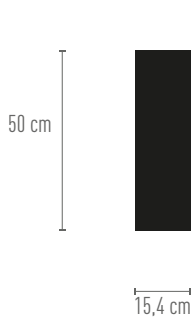
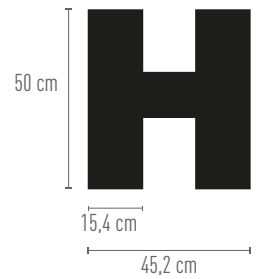
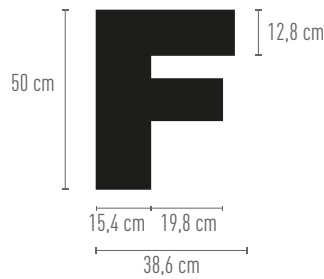
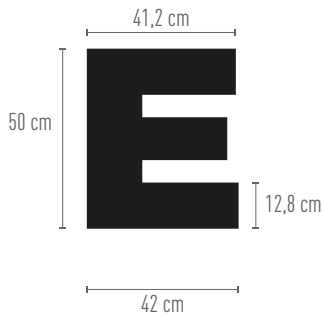
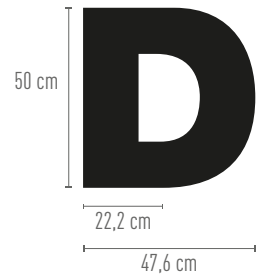
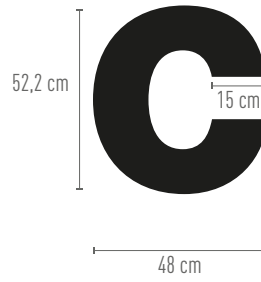
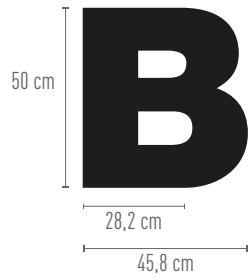
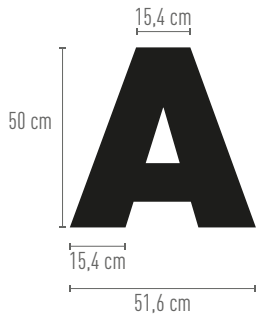

50 cm hohe BUCHSTABEN

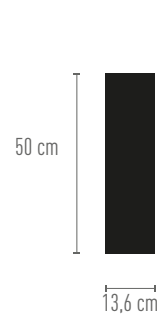
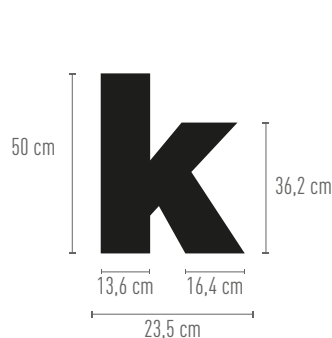
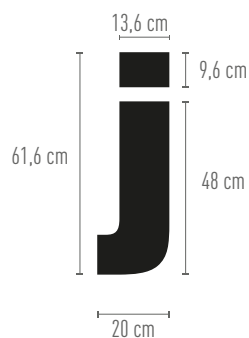
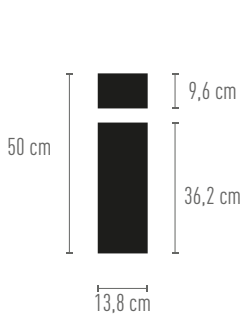
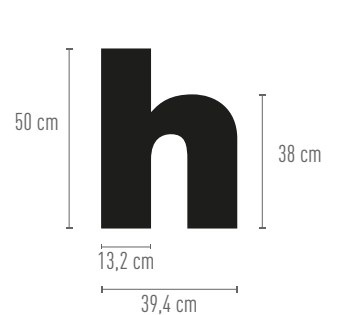
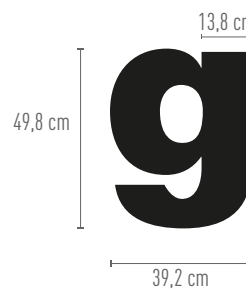
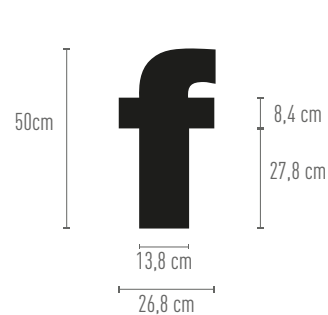
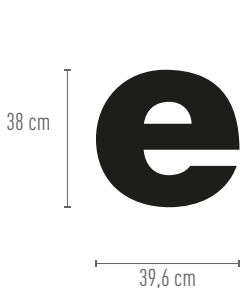
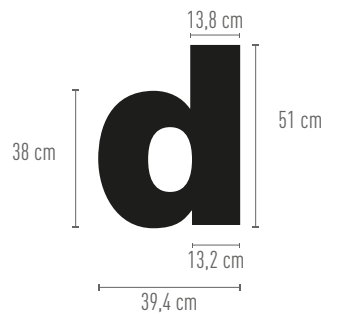
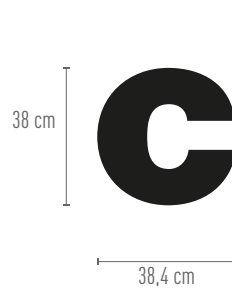
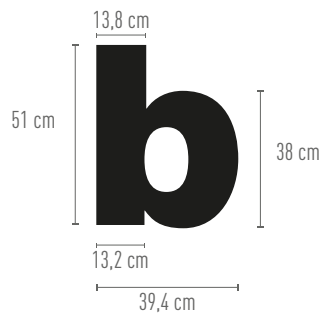
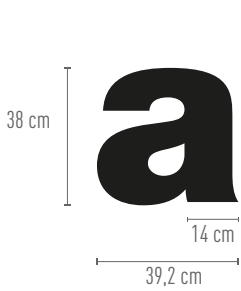
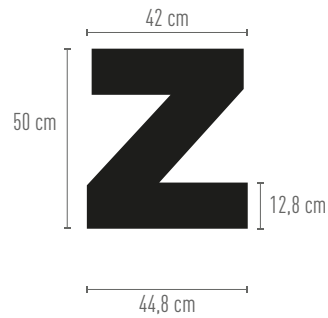
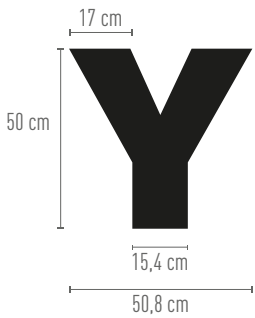
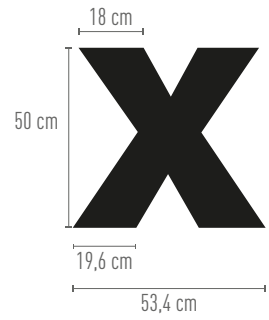
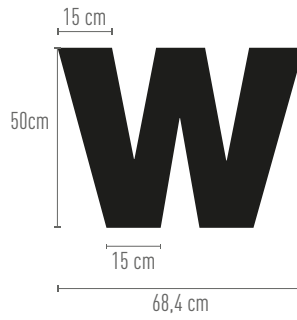
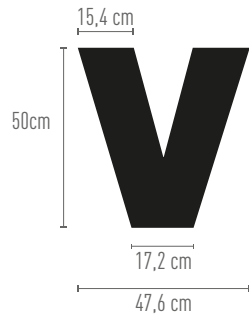
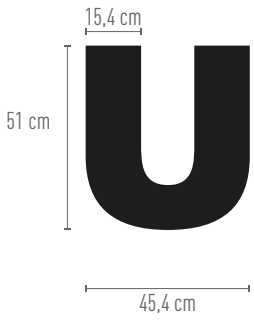

50 cm hohe BUCHSTABEN

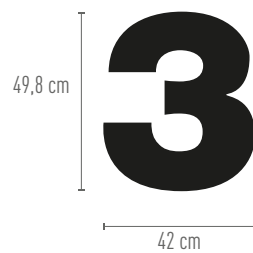
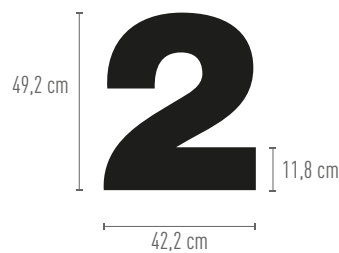
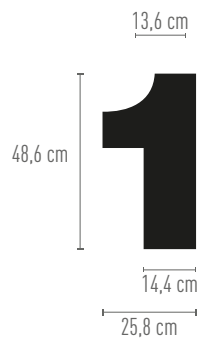
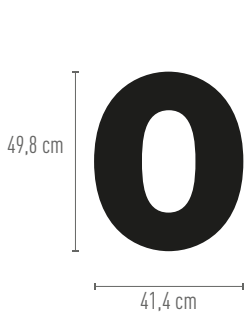
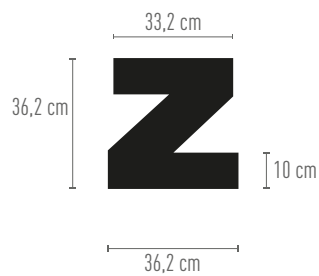
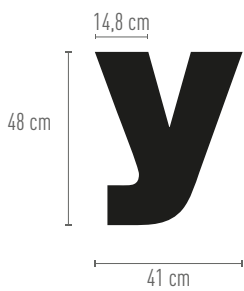
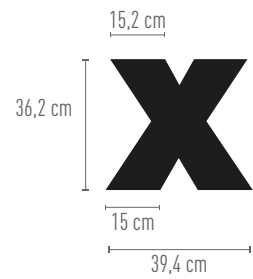
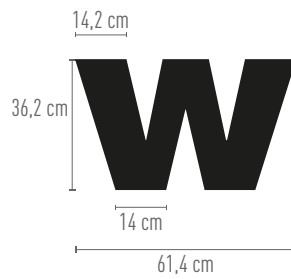
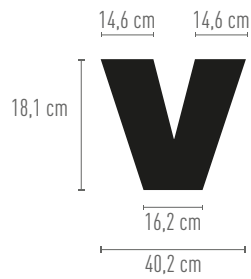
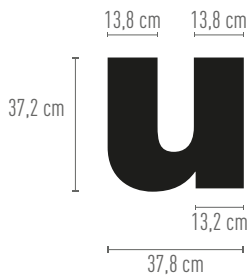
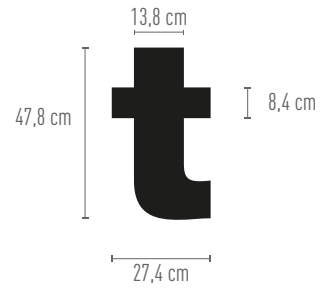
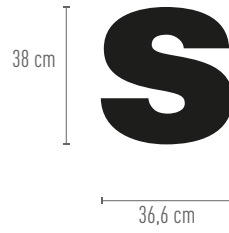
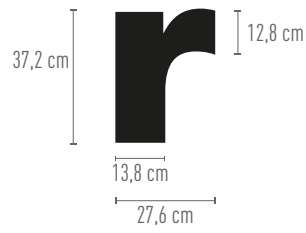
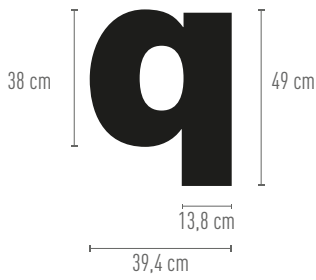
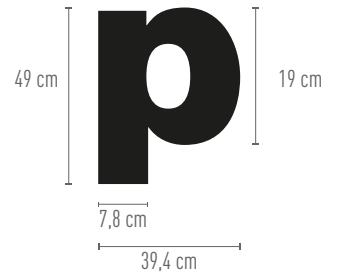
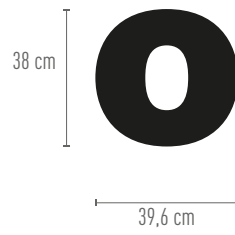
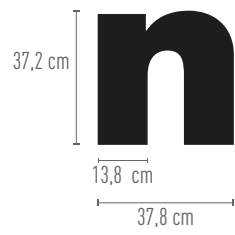
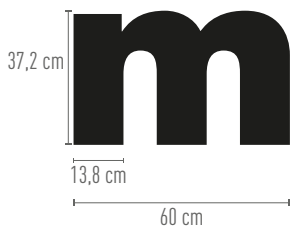

50 cm hohe BUCHSTABEN

